



SBE-44-230 Evaporator Technical Specifications



Model	SBE-44-230	Heat Transfer Surface	31.9 m ²
Capacity	5100.00 Watt	Tube Volume	6 dm ³
Inlet Air Temperature	0 °C	Fin Spacing	4 mm
Evaporation Temp.	-8	Test Pressure	
ΔT	8 K	Max. Operating Pressure	
Refrigerant	R404A	Configuration	
Altitude (1)	0 m	SBE-44-230/	

Fan Specifications

Air Flow	2370 m ³ /h
Fan Diameter	∅ 300 mm
Number of Fan	2
Fan Speed	1380 rpm
Total Power Input	0.124 kW
Total Fan Current	0.56 A
Voltage	230 V
Frequency	50 Hz
Phase	1 Phase
Air Throw Distance	7 m
Sound Power Level (LWA)	73 dBA
Sound Pressure Level (LPA)(2)	51 dBA
Distance @	3 m
Insulation Class	Class B
Protection Class	IP 44
Temperature Range	60 °C

Pricing

Unit List Price	0.00 €
Configuration Price Difference	0.00 €
Unit Sales Price (Excluding Taxes)	0.00 €

Dimensions

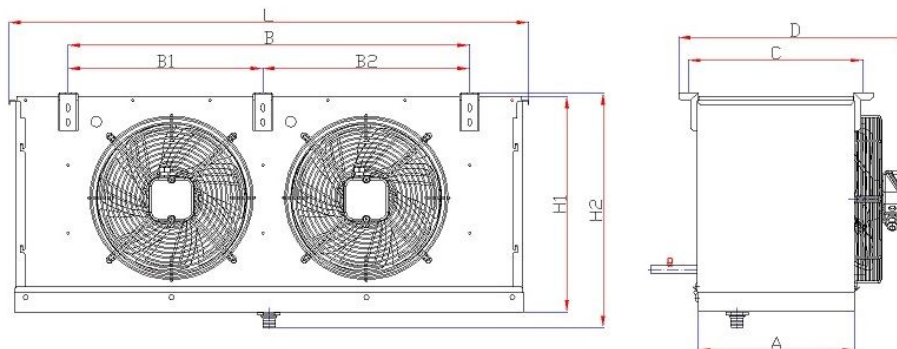

L:1108 mm	H1:444 mm	H2:484 mm	D:477 mm
A:321 mm	B:825 mm	B1: mm	B2: mm
B3:351 mm	C: mm	∅Din:1/2"	∅Dout:28 mm
We:34 kg			

Notes

- 1) Capacity correction calculation for altitude is according to related Eurovent Standard.
- 2) Sound pressure calculation standard: EN13487
- 3) All of the technical information is subject to change without notice.
- 4) All of the performance and technical data according to default configuration.

User Contact Info:

Name and Surname:	Krzysztof Pakulski	Company Name:	allterm
Phone:	+48508142149	Fax:	+48713026827
E-mail:	info@sarbuzz-polska.pl	Web:	sarbuzz-polska.pl
Address	55095 Mirków ul. Wolności 25 İstanbul / Türkiye		

Sarbuzz Soğutma Sanayi ve Tic. Ltd. Şti.
Ömerli Mah. Adnan Kahveci Cad. Seden Sok. No: 14 Hadımköy / Arnavutköy / İSTANBUL/Türkiye
Product Selection Program V 1.0 Gama